

USER MANUAL

MASSAGE BATHTUB SERIES



Contents

- Profile Page 1
- Step of installation Page 1
- Adjustment. Page 2
- Must be executed Page 3
- Attention Page 3
- Maintenance Page 3
- Using skill Page 4
- Basic circuit of massage bath tub Page 4
- Technical parameters Page 5
- Manual Operation Page 5
- Warm Tips. Page 5

Profile

Dear customer:

Thank you for using our massage bathtub. This product series we designed is characterized by its superior material, neat style, comfortable, practical and economical. It is the new generation of leisure product, and it will bring you great relaxation and pleasure bath.

Please check whether the spare parts in order according to the overall chart after opening the packing, and analyze the product structure and installation position of accessory, then start the installation according to the following instruction.

You are welcome to visit our website www.gemy.cn if there is any question.

Step of installation

1. Fitting installation: Open the packing first and take out the bathtub, then install all the fittings.
2. Level test: First, place the massage bathtub at installation point, then check whether it is level by visual test. Second, let proper water in then drain it out, in order to check whether it is at the best state of draining

3. Foot adjustment: Adjust the support foot until it is horizontal.



5. Drainage installation: Install the drainage at the tub bottom first, then connect it to the drain outlet. Please make sure the drain pipe is not flexed.



4. Cold-hot water pipe connection: Move the bathtub slightly toward outside, then install the water pipe with "Cold" or "Hot" mark at the corresponding position.



6. Power connection: Use multimeter to check whether the ground wire in power plug is connect well with the pump surface and support rack, then connect the yellow and green wire with earth. Finally, insert the plug into socket.



Adjustment.

1. First, turn on the cold water valve after the silicon glue is dry, then adjust the hot water valve until the mixed water with proper temperature. Second, twist the water separating valve to the shower function, then adjust the portable shower, to let the water in and clean the bathtub.

2. When the water level reach a proper position, then start the water pump, adjust the water nozzle, check whether the water pump works well and water leaks or not.

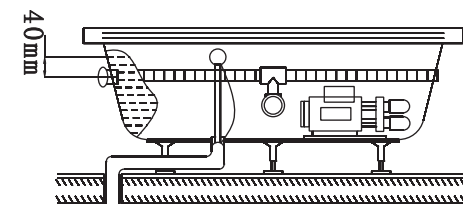

The whole test procedure is complete here. Please read the security attention carefully before using the product, in order to avoid unnecessary damage or loss. Keep the instruction well for subsequent reference after reading.



Warning

1. This product must be installed by the qualified person.
2. The equipotential connection of this product must be jointed in the right way on floor.
3. The wire should be connected with the fixed wiring unit.
4. The wire should be connected with leakage protector and earth wire unit. (Rated current >20A; Rated leakage protector current ≤30mA).
5. Make sure that the supply voltage is compatible with the rated voltage before using.
6. No one should get close to the steam box.
7. Never use other shower functions during steaming process.
8. The person after drinking, or taking sleeping medicine are not allowed to use this product. Hypertensive patient, patient with heart disease and epileptic are not allowed to use this product.
9. Children must be guided to use this product with parent.
10. Earthed appliances must be permanently connected to fixed Wiring.
11. Parts incorporating electrical components, except remote control devices, must be located or fixed so that they cannot fall into the Bath.
12. Equipotential bonding should be carried out, should be carried out
13. This appliance is not intended for use by persons (including Children) with reduced physical, sensory or mental capabilities, or Lack of experience and knowledge, unless they have been given Supervision or instruction concerning use of the appliance by a

Must be executed

1. It is easy to slip because of the soap water in bathtub, please be careful.
2. Please pay attention to enter bathtub so as not to stumble.
3. Make sure the water reach the proper position when start the water pump.
4. Turn on the cold water valve first when let the water in or use the portable shower, then adjust the hot water valve until the water with appropriate temperature, so as not to be scalded.
5. Let appropriate water in to clean the bathtub, in order to use conveniently next Time.
6. Please turn off the water valve and draw the plug out, if you will not use the bathtub for long time.







Attention

1. Please don't hit or scratch the bathtub with hard object.
2. Water will leak if the silicon glue desquamate, please make it up once it fall off.
3. Don't use chemical such as acid, alkali, drugs (eg. Hydrochloric acid), solvents etc., To clean the bathtub. Because the chemical mentioned above is bad for health.

Maintenance

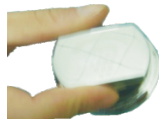
1. Preheat the bathtub with warm water (18-20°C) before using, if the room temperature is too low. Please do not let hot water (more than 50°C) hit bathtub directly. Drain the water completely after using, then wipe the bathtub up with soft cloth. Make sure there is no water left in the bathtub, because the left water may freeze.
2. If the bathtub is slightly dirty, please use soft cloth or sponge with neutral cleanser to clean. Don't clean the bathtub with nylon product, because it will reduce luster of acrylic. Clean the dirt with flannelette which smeared with toothpaste. The detergent such as acetone, ammonia water and the organic solvent are forbidden to clean the bathtub. Don't sterilize the bathtub with formic acid and druggery includes formic acid, otherwise it will damage the bathtub surface.
3. Maintenance of gold-plating accessory: Wipe the gold-plating accessory up lightly with flannelette, should not try with rough cloth.
4. Wipe the bathtub with NO2000 sanding paper when it is scratched, then polish it with flannelette and toothpaste.

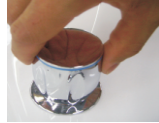
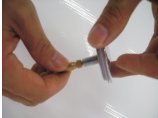
Using skill

<p>1. water output adjustment: Rotate the water nozzle deasil to adjust its water output.</p> 	<p>6. Motor start: Press the air switch to let the massage pump on or off.</p> 
<p>2. Direction adjustment of water output: Move the water nozzle toward the directions you like.</p> 	<p>7. Massage intensity adjustment: Twist the air switch to adjust the massage intensity.</p> 
<p>3. Sundries cleaning of drainage: Take off the cover to clean away sundries under the drainage.</p> 	<p>8. Cold water valve adjustment: Twist the cold water valve to regulate output volume.</p> 
<p>4. Drainage adjustment: Adjust the copper screw of water plug to control the drainage volume.</p> 	<p>9. Water separating valve: Twist the valve to switch the function of portable shower and water in fall.</p> 

5. Sundries cleaning of water circulation cover: Rotate the cover clockwise to take it off, then screw it on after cleaning.



10. Hot water valve adjustment: Twist the valve to adjust hot water output of portable shower and water in fall, also with function of



11. Portable shower adjustment. Hold the portable shower pole, then twist the shower head to adjust the volume of water output. There are many kinds of shower function.



Basic circuit of massage bath tub

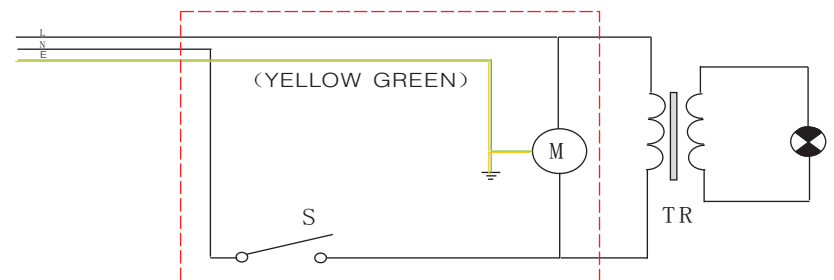

S — Pneumatic Switch

M — Pump Motor

TR — Transformer

L — Underwater lights

Technical parameters

Working conditions and characteristics

Rated Voltage	<input type="checkbox"/> AC220V~AC240V		<input type="checkbox"/> AC100V~AC120V	
Rated current	10A	Rated frequency	<input type="checkbox"/> 50Hz/ <input type="checkbox"/> 60Hz	
Insulation Resistance	>20M	Waterproof grades	IPX5	
Load configuration parameters				
Load category	Rated load voltage	Rated load frequency	Rated load power	Other
Pump	_____	_____	<input type="checkbox"/> 1Hp <input type="checkbox"/> 1.5HP <input type="checkbox"/> 2Hp	_____
Wind Pump	_____	_____	<input type="checkbox"/> 300W	_____
Thermostat	_____	_____	<input type="checkbox"/> 1500W	_____
Ozone	AC12V	_____	<input type="checkbox"/> 9W	_____
Underwater lights	AC12V	_____	<input type="checkbox"/> 3W	_____
TV	DC12V	_____	_____	_____
DVD	DC12V	_____	_____	_____

Note: Rated given load power , internal fight √, saying that this Massage Bathtub with this configuration

In order to ensure the normal using of Massage Bathtub, the hydraulic pressure in the connecting pipe required:

Maximum hydraulic pressure ≤ 1.0MPa

Minimum hydraulic pressure ≥ 0.3MPa

- When the hose between massage bathtub and water pipe is changed into new one, then the old hose can't be used anymore.

Failure solution

Problem	Possible reason	Solution
Pump cannot start	The water level has not reached the probe	Continue adding water, let the water level reach the probe
	Air driven switch faulty	Replace
	Loose plug	Fix the plug
	Pump jammed with rubbish	Clear the blockage
Massage failure	Pump is damaged	Replace
	Failure of adjuster	Replace the sealing rubber ring inside
Leakage	Air pipe leakage or loose connection	Clearing the blockage tighten the connection
	Join rings broken	Replace
	Lock nut may be loose	Tighten the nut
Shaking is too Severe	Adhesive glue aging	Use new adhesive glue
	Ground bolt is loose or free	Adjust ground bolt to touch the ground
Pump runs but the lamp is not working	Backwater is jammed	Clear the rubbish in Strainer
	Lamp circuit is not closed	Fix the lamp circuit
	Bulb is damaged	Replace
	Transformer is damaged	Replace

Ware tips

Due to the continuous improvement of products, you get instructions in the product may be inconsistencies with the real subject, I apologize! Remind you once again, if necessary, service, please contact your local dealer or call the customer service hotline at Division I! We will warmly serve you!

Foshan Ailihua Sanitary Ware Co., Ltd
 Add: Laocun Section, Sanle Road,
 Lecong Town, Shunde, Foshan, China
 Tel: +86- 757-28100116
 Fax: +86- 757-28100121
 Email: export@gemy.cn



G9257

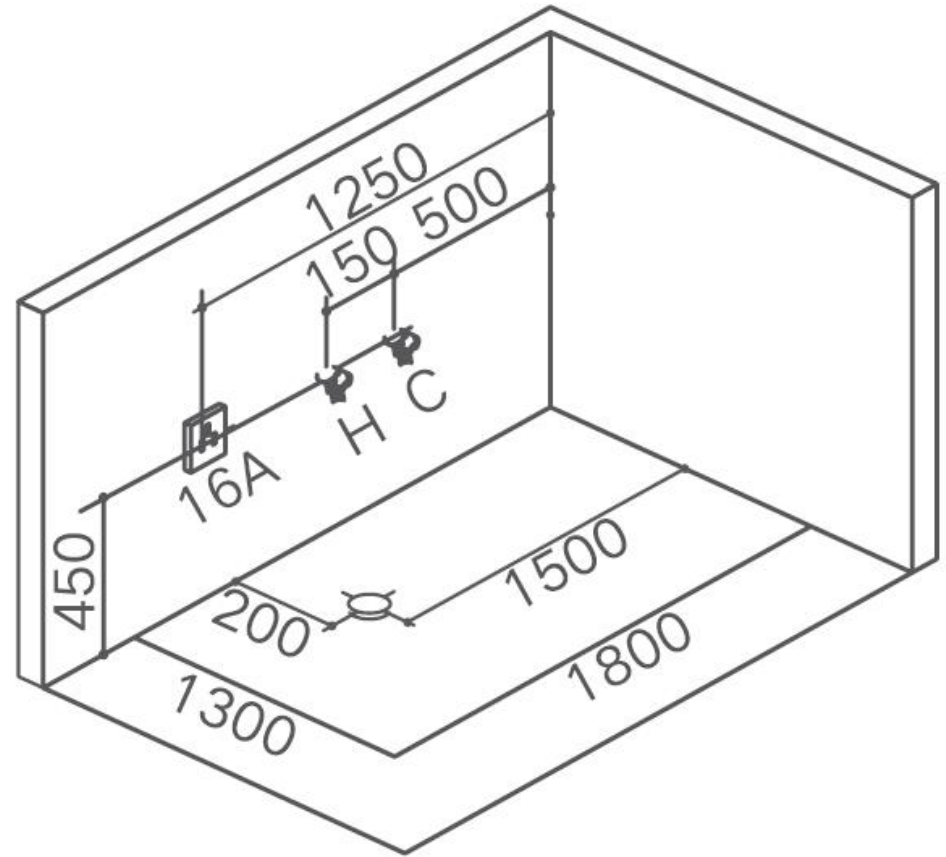
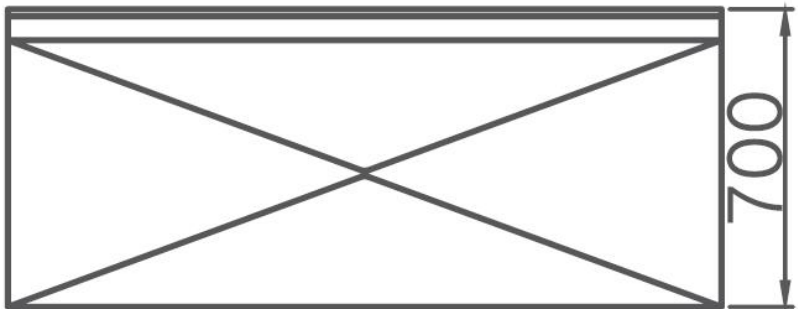
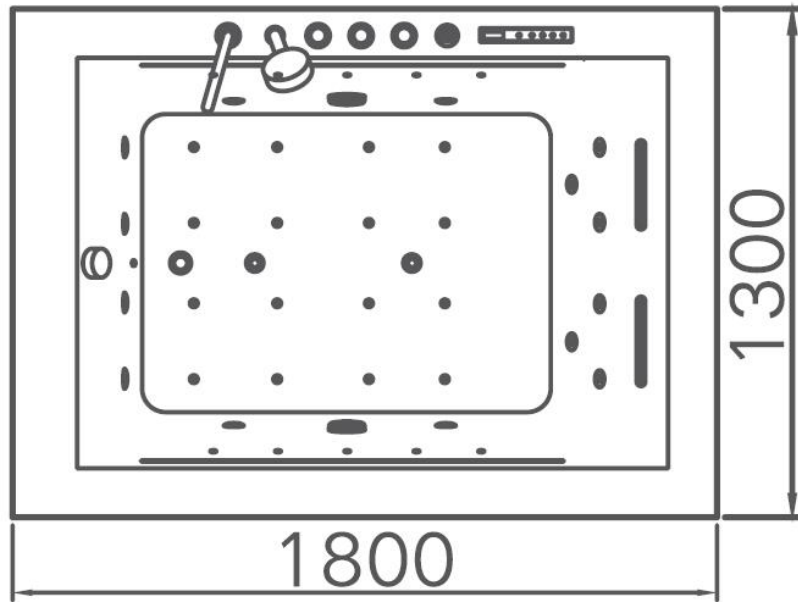

Senior massage bathtub computer controlled system

Product functions

Luxury blue mini dynamic display & Easy using

1. Testing water level automatically by computer
2. Surfing
3. Bubble bath
4. High sensitive FM radio with 10 channels, electronic and digital turning, and automatic selection etc.
5. Ozone sterilization and disinfection (Optional)
6. CD input
7. Under-water lamp
8. Wireless remote controller with full functions.
9. High-tech sensor instead of the traditional button, more easy using.
10. External Thermostat (Optional)

Techology parameter

1. Power: AC220V±10% 50-60Hz
2. Water pump power: AC220V≤1000W
3. Wind pump power: AC220V≤750W
4. Dielectric strength: 1500V 1min
5. Leakage current: <0.25mA
6. Waterproof grade: IPX4
7. Ozone(Optional): AC12V≤10W
8. Over-loading underwater lamp: AC12V≤20W
9. Music power: ≤10W
10. Frequency range: FM 88-108MHz
11. SNR: >45dB
12. Thermostat power(Optional): AC220V≤1500W

Installation diagram

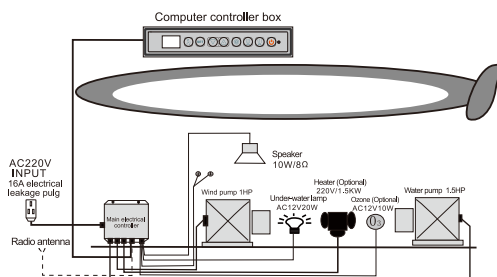

Wiring diagram

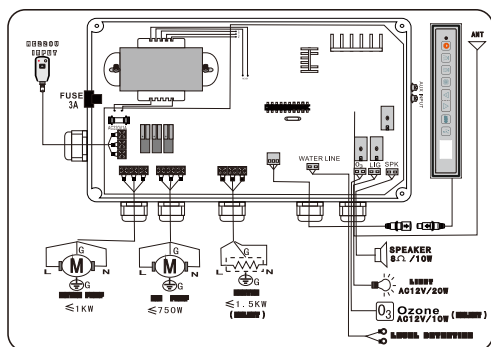

Panel function instructions

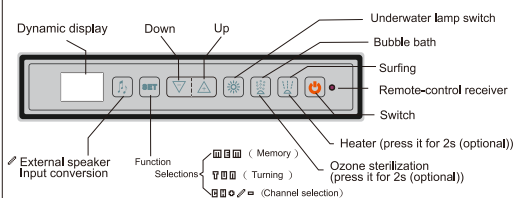

Remote controller using

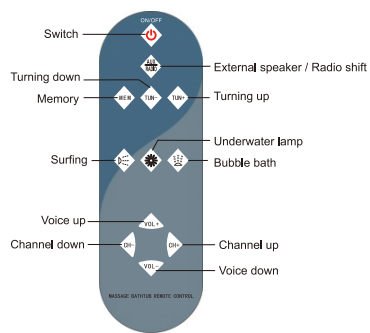

Operation instruction

1. Surfing

1) Switch operation: Insert leakage switch and press power on () to open the power. The display shows and actual temperature if it is with heater function. User can setup each functions as your requested. Press () to close the system.



Without heater



With heater, actual temperature showing (optional), Interval twinkling display setting temperature.

The bathtub with heater can preset temperature on condition that the radio is power off. Press () or () can change the setting temperature.

2) Surfing function

Press Surfing button () on the faceplate to start surfing pump after the water level in bathtub get to the standard water level. The display also shows dynamic surfing mark. Press Surfing button () on the faceplate again to stop the surfing pump. The surfing mark in display will be also appeared. Water pump will be closed automatically per 60 mins. (Remark: When the water level in bathtub don't get to the standard water level, Surfing pump can not be started by pressing Surfing button () on the faceplate. The display just shows static surfing mark " " and twinkling water shortage mark " ", which means you should put water into the bathtub now.

3) Heater function (Optional)

Start or stop external thermostat by long -pressing () over 2s, on condition that it is on Surfing function. The Heater function mark () will be on or off accordingly in display. (Remark: The function is controlled by surfing function. The eater can be work only after the surfing function is started, otherwise, it will be closed.)

4) Bubble Massage function:

Start or stop bubble massage function by short - pressing () bubble button. The bubble mark will be shown accordingly in display.

5) Underwater lamp function

Underwater lamp will be opened when start the system everytime. You can press the underwater lamp button () to start or to shut down. The underwater lamp mark will be shown accordingly in display.

6) Ozone disinfection function

Start or stop Ozone function by long-pressing () over 3s. The Ozone mark will be shown accordingly in display. The working time of Ozone function can be setup 15 minutes.

2. Radio

1) The display will show radio frequency after making the antenna be "Y" shape and shifting radio function by pressing (). Meanwhile, the voice volumn will be up from 0 to 15DB and there is some voice in the speaker.

2) Turning: You can turn radio by pressing () or () to select channel you like after pressing () for 2s and showing "TUN" in display. Short pressing is manual turning. Long pressing over 3s is automatic turning until it receive a signal. We suggest you use manual turning when it's difficult to receive a signal.

3) Memory: After you choose the channel, you can press () and the display will show " M-01 " Then you can save the channel you selected just now to No. 1 place. If you continue to save the channel, the place number will increase by degrees. The range of the place number is from M- 01 To M- 20.

4) Selecting channel

You can listen in the channel what you saved by pressing () and the display will show " CH01-CH20".

The step of selecting and Memory

Long pressing ()

- pressing () or () after the display shows " TUN".
- pressing () after the channel is searched.

Repeated listening step

Pressing () ——selecting the channel where you saved.

5) Voice adjustment

Pressing voice () or voice () can adjust the voice and the display will show DB number accordingly

3. External speaker function

Connect the audio of external speaker with the external socket of the main controller box with swich " AUX " by pressing (). Finally adjust the voice you need.

4. Power off

Close all functions by pressing () and the display will show (off) and go out. The system is stand- by. If you don't use it for a long time, please pull out the plug.

Failure clearing

Failure	Reason	Solution
Failure of power on	1. The leaking plug is not connected with power. 2. The failure line connection between controlle and main electronic controller.	1. Checking if the Indicator light is off, if yes, please connect with power. 2. Connect again.
Underwater lamp off	1. The line of underwater lamp is loosen. 2. Broken lamp.	1. Connect again. 2. Change lamp.
Bad signal	1. Antenna is not pulled out. 2. Radio frequency is not adjusted well. 3. Bad signal.	1. make antenna be pulled out and be right position. 2. Re-adjust radio frequency. 3. Geography reason.
Soundless speaker	1. Voice is too low. 2. The plug of speaker is loosen. 3. Bad speaker.	1. Make voice louder 2. Connect again 3. Change speaker
Bad remote controller	Low capacity of battery	Change battery

NOTICE

1. The system should be installed by professional people. The leaking plug should be installed what you can control it easily.
2. The system must be installed firmly on the ground. If there is any lose because of the bad installation on the ground, the factory will not take the responsibility.
3. The Motor should be installed firmly and flat. The cover should be installed on the ground firmly.
4. Please pull out the plug if the machine is stand-by and not used for a long time.
5. Please take the over-loading of electrical line into consideration. Otherwise, it will impact the normal use or safe accident.
6. Please pay more attention to moisture-proof solution when you install it.